











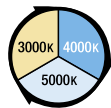

Replacement  
Warranty\*

# 350MM SLIMLINE TRICOLOUR LED CEILING LIGHT

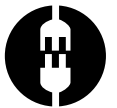
TLHO34518WD

The Hilux surface mounted LED ceiling light is a simple and sleek designed light that features an 18W Tricolour SMD LED light that is encased with a toughened acrylic diffuser. Making this light ideal for kitchens, hallways and other high traffic areas.



 Tricolour LED	 Energy Efficient	 CRI ≥80	 IP 44	 Quick Connect System
 LED Type	 Step Dimming Function	 Watt / Lumens	 LED Lamp Life	 Beam Angle

- Surface mounted LED ceiling light
- Ideal for kitchens, hallways and high traffic areas
- Provides excellent light distribution using SMD LED technology
- 18W Tricolour LED light
- Simple & sleek design with a toughened acrylic diffuser

## INCLUDES

Lamp cover, main body, wall mount screws, sealing ring & insulation tube

## DIMENSIONS

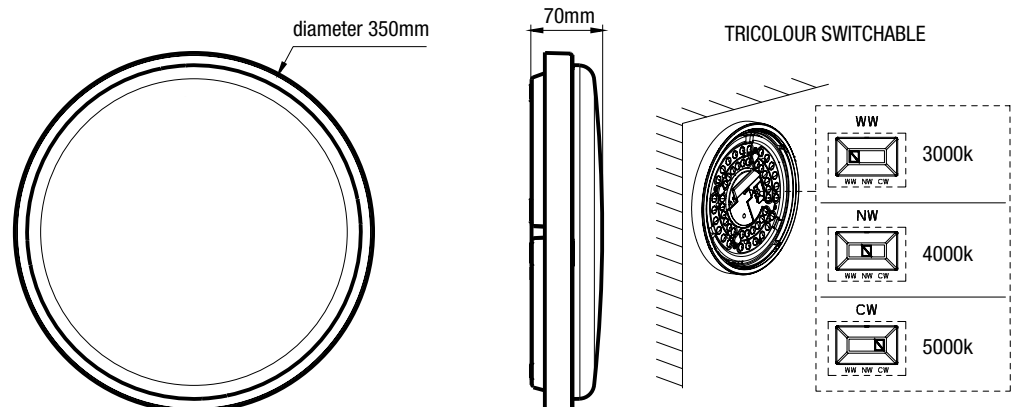

Aust/NZ Approval No.  
GMA-505963



9312375506270

TLHO34518WD

350MM SLIMLINE TRICOLOUR LED CEILING LIGHT

FEATURES

- Slimline surface mounted LED ceiling light
- Provides excellent light distribution using Tricolour SMD LED technology
- Select either 3000k, 4000k, or 5000k light colour temperature setting
- Toughened acrylic diffuser
- Simple, round and sleek design
- Complete with integrated driver
- Switch dimming function: 100% lumen – 50% lumen – 10% lumen output
- IP44 weather resistant

SPECIFICATIONS

Model name	Hilux
Model number	TLHO34518WD
Power (wattage)	18W
Voltage	220v-240v
Frequency	50-60Hz
Switchable Tricolour lumens	3000k-1100lm 4000k-1200lm 5000k-1200lm
Colour temperature	3000k / 4000k / 5000k
LED light beam angle	120°
Product size (mm)	Dia 350 x 70
Material	Toughened acrylic diffuser
LED Type	24 x 0.75W SMD LED
CRI	≥80
Switch dimming function	100% lumen – 50% lumen – 10% lumen output
Approximate lamp life	25000hrs
Weather resistance rating	IP44
Driver type	Integrated driver



INSTALLATION

Installation	By licensed electrician only
Warranty	2 year replacement warranty*

\* For further information regarding warranty terms and conditions, please refer to enclosed warranty statement. Warranty is void unless installed by a licensed electrician.

SHIPPING

Packaging size	355 x 360 x 80mm
Gross weight	4.8kg
Carton qty	8

AVAILABLE IN WHITE



White

Model	Colour	Barcode
TLHO34518WD	White	 9312375506270